

Low Risk Site Handbook for Erosion Prevention and Sediment Control



February 2020

Vermont Department of Environmental Conservation
Watershed Management Division
1 National Life Drive
Montpelier, VT 05620-3522

dec.vermont.gov/watershed/stormwater



Low Risk Site Handbook for Erosion Prevention and Sediment Control

A construction stormwater discharge permit must be obtained for construction activity that results in total land disturbance of equal to or greater than 1 acre, including construction activities where disturbance is less than 1 acre, but is part of a larger common plan of development, if the larger development will ultimately result in the disturbance of 1 or more acres.

Vermont Construction General Permit (CGP) 3-9020 guides an applicant in assessing the potential risk to water quality from the proposed construction activity and categorizes the project activity as Low Risk, Moderate Risk, or that which requires an Individual Permit.

The practices in this handbook serve as the required Erosion Prevention and Sediment Control Plan for construction activity that is determined to be “Low Risk” under CGP 3-9020.

Table of Contents

Section 1: Introduction

What is erosion prevention and sediment control? . . 1

Acknowledgements

Some design details and standards were adopted from those provided by: Vermont Electric Power Company (VELCO), TRC Solutions, Connecticut Department of Transportation (CTDOT) and the New York Department of Environmental Conservation (NYDEC).

Section 3 Additional Resources

How to calculate slope:

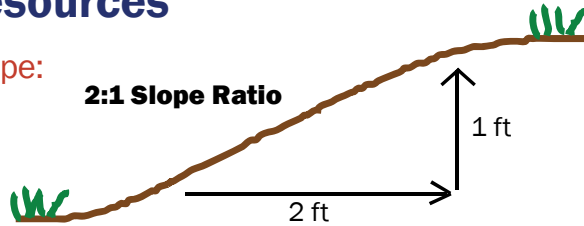

Approximate Slope Conversions			
Steepness	Percent	Slope ratio (ft/ft)	Degrees
Very steep	100%	1:1	45°
	50%	2:1	27°
Moderate	33%	3:1	18°
	25%	4:1	14°
Slight	10%	10:1	6°
	5%	20:1	3°

How to estimate disturbance area:

1 acre = 43,560 square feet = 4,840 square yards

Area in acres (width in feet x length in feet)						
(w) x (l)	100	150	200	300	400	500
100	0.2	0.3	0.5	0.7	0.9	1.1
150	0.3	0.5	0.7	1.0	1.4	1.7
200	0.5	0.7	0.9	1.4	1.8	2.3
300	0.7	1.0	1.4	2.1	2.8	3.4
400	0.9	1.4	1.8	2.8	3.7	4.6
500	1.1	1.7	2.3	3.4	4.6	5.7

Section 2: The Requirements

1. Demarcate Limits of Disturbance.....	3
2. Pollution Prevention	5
3. Limit Concurrent Earth Disturbance	7
4. Site Stabilization	9
5. Stabilize Construction Access	14
6. Divert Upland Runoff	17
7. Install Perimeter Controls	21
8. Storm Inlet Protection	33
9. Water Bars	37
10. Slow Down Channelized Runoff	39
11. Slope Stabilization	45
12. Winter Construction Requirements	49
13. Dewatering Activities.....	55
14. Concrete Washout.....	57
15. Permanent Controls.....	59
16. Inspection, Maintenance, and Discharge Reporting	61

Section 3: Additional Resources

How to calculate slope.....	63
How to estimate area.....	63

Section 1 Introduction

What is erosion prevention and sediment control?

Stormwater runoff carrying sediment into streams, lakes, and wetlands is a large contributor to surface water quality problems in Vermont. Sediment discharges from unmanaged construction sites can adversely impact aquatic habitat, and may have lasting impacts on fish and other aquatic organisms.

On most construction sites, the existing vegetation that holds the soil in place and protects it from the erosive forces of rain and runoff is removed, leaving large areas of soil exposed. During rainfall or snowmelt, the exposed soil may be easily eroded and transported to nearby streams, lakes, or wetlands*.



If after maintaining and supplementing BMPs, a discharge of visibly discolored stormwater from the construction site to surface waters continues, the permittee is required to notify DEC within 24 hours.

While documentation of a routine inspection is not required, example inspection forms and forms for required discharge reporting are available at the Stormwater Program website. Permittees shall review Construction General Permit 3-9020 for all discharge reporting requirements.

- A copy of the Low Risk Site Handbook shall be kept on-site.
- Daily inspections are required from October 15 through April 15.

16. Inspection, Maintenance, and Discharge Reporting

Site inspections are required to ensure that all erosion prevention and sediment control practices are sufficient and functioning properly. Regular inspections and maintenance of practices will help to reduce costly repairs and minimize the risk to water quality from construction stormwater discharges.

Requirements:

Inspect the site at least once every 7 days and after every rainfall or snowmelt that results in stormwater runoff. Perform maintenance to ensure that practices are functioning according to the specifications outlined in this handbook.

In the event of a visibly turbid discharge from the construction site, you must take immediate action to inspect and maintain existing erosion prevention and sediment control practices. Additional erosion prevention and sediment control measures must be installed as necessary, including temporary stabilization, to minimize and prevent the discharge of sediment laden stormwater runoff.

To prevent this from happening, a small number of practices to prevent erosion and contain soil on the construction site must be used. The most effective approach to prevent a sediment discharge is temporary and final stabilization of exposed soils. Controls for sediment laden runoff are necessary at times, but should not be used as the primary means of prevention.

*Projects involving work within a jurisdictional (perennial) waterway for stream alteration, please contact your regional River Management Engineer for technical and permitting assistance.

*Projects involving work within or adjacent to jurisdictional lakes or buffers, please contact your regional Lakes and Ponds permitting staff for technical and permitting assistance.

*Projects involving work within jurisdictional wetlands or buffers, please contact your regional Wetland Ecologist for technical and permitting assistance.

Section 2 The Requirements

1. Demarcate Limits of Disturbance

Purpose:

Delineating the site will help to: limit the area of disturbance to only what is necessary for construction, prevent unauthorized disturbance, preserve existing vegetation, and limit erosion potential on the site.

Requirement:

You must physically mark the limits of construction activity using one of the methods described below.

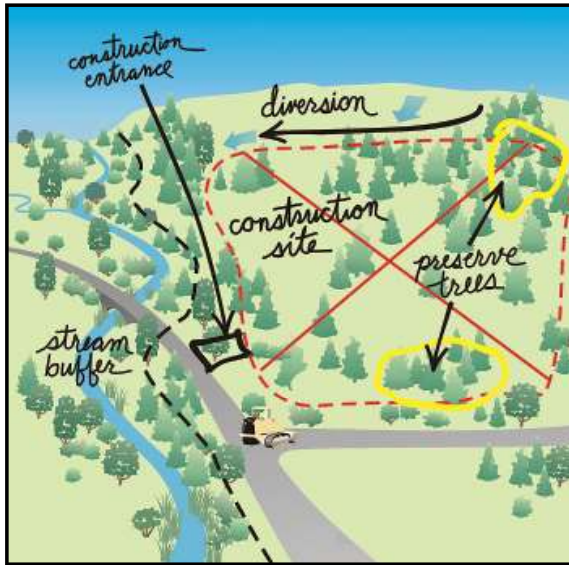

Infiltrating stormwater practices such as this bioretention system should be kept offline until the drainage area has been fully stabilized.



Install all permanent stormwater treatment practices before constructing any impervious surfaces on site. This stormwater wetland treats stormwater runoff from the adjacent parking lot.

15. Permanent Controls

Permanent stormwater treatment practices are constructed to maintain water quality, preserve existing water table elevations, prevent downstream flooding, and are often required for a project under a Vermont operational stormwater discharge permit applicable to the construction or redevelopment of impervious surfaces.*

Permanent Stormwater Treatment Practices (STPs) include infiltration and filtering practices as well as detention ponds and treatment wetlands. **It is critical that infiltration practices do not receive runoff until the site area has reached final stabilization.**

The outlet of permanent controls that are used as temporary storage and sediment basins during construction constitutes a potential discharge point and therefore must be managed to minimize and prevent sediment laden stormwater discharges. These practices will often need to be reshaped to meet the operational design criteria for volumes, grades and geometry once final grading and stabilization has occurred.

*An impervious surface is a manmade surface, including, but not limited to, paved and unpaved roads, parking areas, roofs, driveways, and walkways, from which precipitation runs off rather than infiltrates.

How to comply:

Before initiating any earth disturbing activities, install a perimeter fence, orange barrier tape, or flagging on stakes or trees to physically demarcate the approved limits of earth disturbance.



Properly placed barrier tape marks the boundaries and limits of construction on this site.



Demarcate Limits of Disturbance

2. Pollution Prevention

Purpose:

Many construction sites require storage of chemicals and materials that have detrimental effects if released into our waterways. A storage plan for these potential pollution sources as well as a spill prevention and clean up plan are required to mitigate these risks.

Requirement:

Design, install, implement, and maintain effective pollution prevention measures to minimize the discharge of pollutants. At a minimum, such measures must be designed, installed, implemented and maintained in accordance with the following requirements.

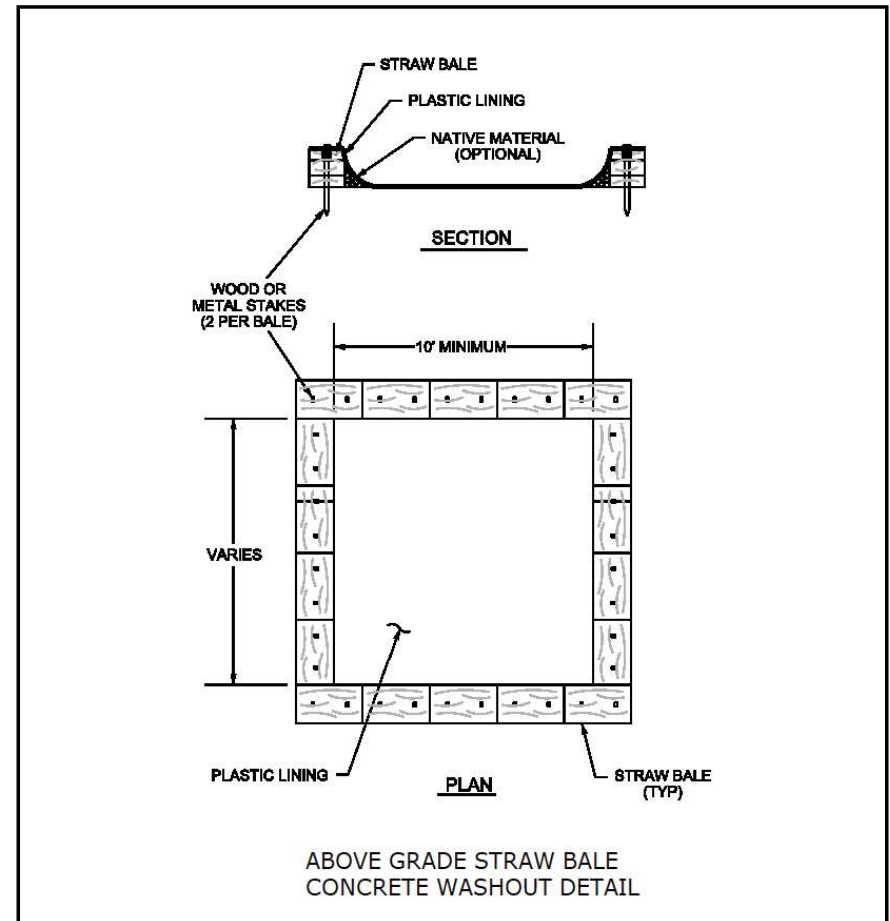

14. Concrete Washout

Purpose:

Concrete wash water often contains a slurry of heavy metals, can be caustic, and has a high pH. As a result, concrete washwater is not a permitted discharge.

Requirements:

Concrete washwater and excess washout concrete should go in a lined washout. This washout should be accessible to the cement truck and at least 50 feet away from stormwater inlets and surface water.

Concrete Washout Installation:

If cement washout is going to occur on site, a lined concrete washout as shown below shall be used onsite. Care should be given to assure that the washout does not overtop during a storm event. Proprietary lined and contained concrete washout basins may also be utilized in accordance with manufacturer's specifications.

Concrete Washout Maintenance:

Concrete washout shall be pumped to a concrete truck as necessary, for disposal or reuse at a batch plant. Washout may also be allowed to evaporate/harden for disposal in accordance with all applicable local, state, and federal regulations.

How to comply:

1. Minimize the exposure of the following to precipitation and to stormwater:
 - building materials,
 - building products,
 - construction wastes,
 - trash,
 - landscape materials,
 - fertilizers,
 - pesticides,
 - herbicides,
 - detergents,
 - sanitary waste, and
 - other materials present on the site.
2. Minimization of exposure is not required in cases where the exposure to precipitation and to stormwater will not result in a discharge of pollutants, or where exposure of a specific material or product poses little risk of stormwater contamination (such as final products and materials intended for outdoor use).

3. Limit Concurrent Earth Disturbance

Purpose:

Limit the amount of soil exposed at one time to reduce the potential erosion on the construction site.

Requirement:

The maximum area of concurrent earth disturbance is specified on the site's written authorization to discharge. Earth disturbance at any one time cannot exceed the maximum concurrent disturbance identified in the authorization. Areas that are at final stabilization or that have been temporarily stabilized in accordance with Section 4 of this handbook, are not counted toward the maximum concurrent disturbance area.

- Route dewatering pump to vegetated area at least 50 feet from surface waters and at a slope no greater than 5%.

Remove accumulated sediment after the water has dispersed or infiltrated and stabilize the area with seed and mulch as necessary. A sufficient area of vegetation greatly improves the efficacy of filtering/settling of turbid water discharged from a dewatering enclosure.

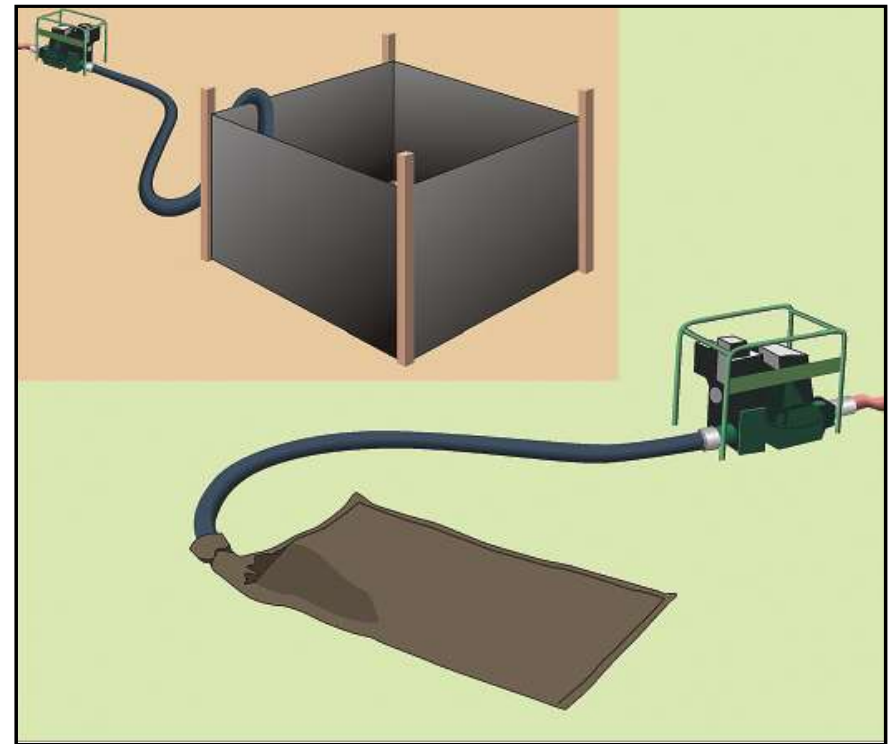

Water is pumped from the construction site into a silt fence enclosure on a vegetated area or into a sock filter away from waterways.

13. Dewatering Activities

Purpose:

To minimize and prevent discharges of sediment as a result of dewatering activities.

Requirements:

Stormwater and groundwater from dewatering activities shall be uncontaminated and shall be filtered or passed through a sediment trapping device, or both, and routed in a manner that does not result in visually turbid discharges to waters. Pump intake for dewatering must be at or near the surface of the ponding area to prevent disturbance of the settled material. Visually turbid water must not be pumped directly to storm drains or other conveyance that leads to waters without implementing one or more of the practices described below.

How to comply:

Implement one or more of the following practices when dewatering:

- Implement sock filters or sediment filter bags on dewatering pump discharge hoses or pipes.
- Route dewatering pump into silt fence enclosures or into staked hay bale enclosures lined with fabric.

How to comply:

Plan ahead and phase the construction activities to ensure that no more than the permitted maximum concurrent acreage is disturbed and unstabilized at one time.

Be sure to properly stabilize exposed soil using one of the methods introduced in Section 4 of this handbook before beginning work in a new section of the site.

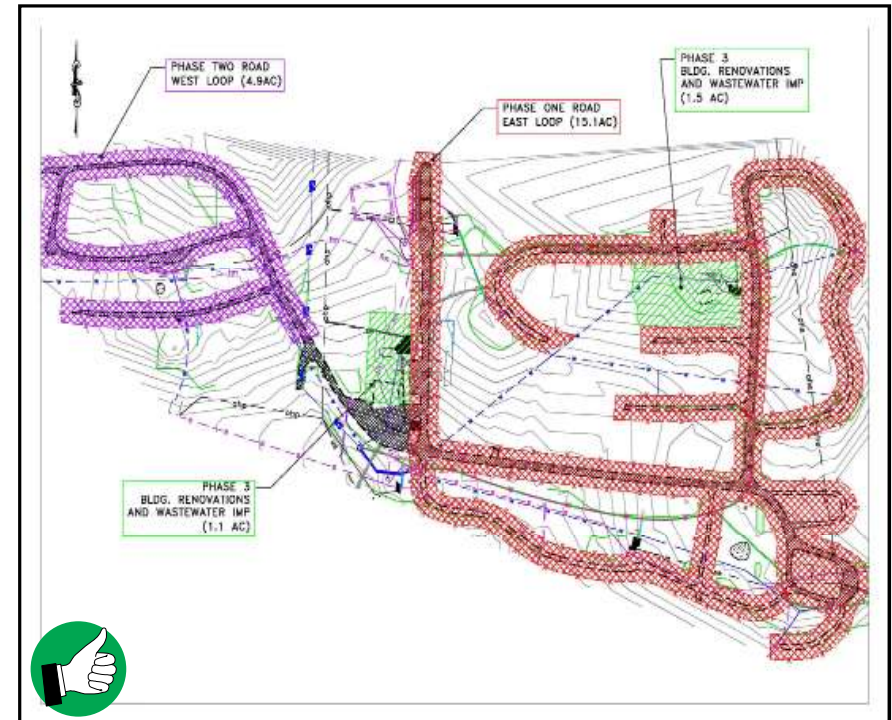

4. Site Stabilization

Purpose:

Seeding and mulching, applying erosion control matting, and hydroseeding are all methods to temporarily stabilize exposed soil and prevent soil erosion prior to vegetative growth. Mulches and matting protect the soil surface while grass is establishing. Areas of earth disturbance may also be stabilized with stone, such as rip-rap or gravel, or other impervious surfaces such as pavement and concrete.

Requirements for Temporary Stabilization:

All areas of earth disturbance must have temporary or final stabilization within 14 days of initial disturbance, as stated in the project authorization. After this time, disturbed areas must be temporarily stabilized or permanently stabilized in advance of any runoff producing event. A runoff producing event is an event that produces runoff from the construction site.

The following exception applies:

- Temporary stabilization is not required if the work is occurring in a self-contained excavation (i.e. no outlet) with a depth of 2 feet or greater (e.g. house foundation excavation, utility trenches), provided any dewatering, if necessary, is conducted in accordance with Part 13.

7. To ensure cover of disturbed soil in advance of a precipitation or melt event, areas of disturbed soil must be stabilized prior to any runoff producing event.
 - Stabilization is not required if the work is occurring in a self-contained excavation (i.e. no outlet) with a depth of 2 feet or greater (e.g. house foundation excavation, utility trenches), provided any dewatering, if necessary, is conducted in accordance with Part 13.
8. Prior to stabilization, snow or ice must be removed to the extent practicable.
9. Use stone to stabilize areas such as the perimeter of buildings under construction or where construction vehicle traffic is anticipated. Stone paths should be sufficient width to accommodate vehicle or equipment traffic.

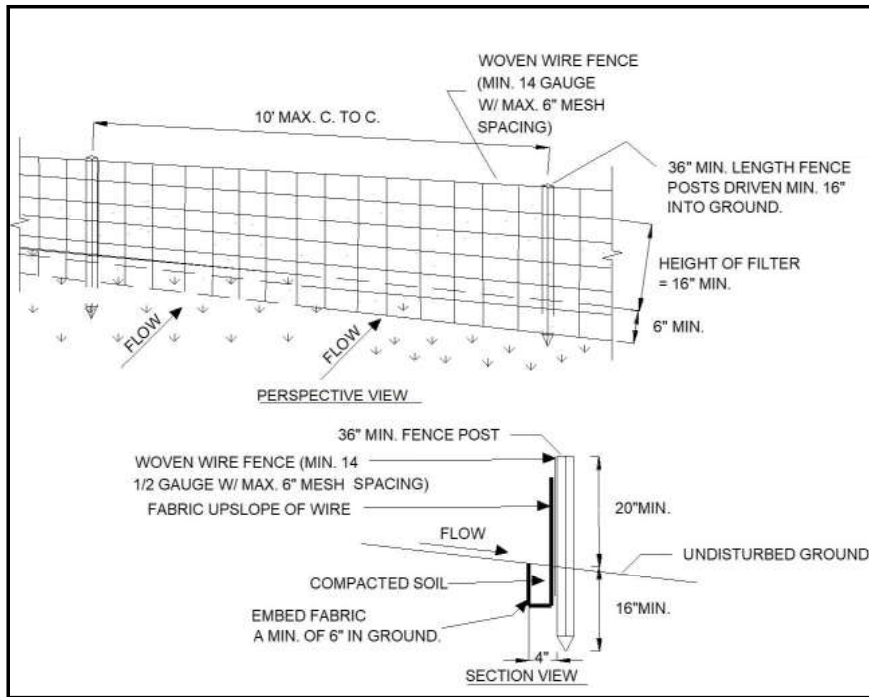

4. Drainage structures must be kept open and free of snow and ice dams.
5. Silt fence and other practices requiring earth disturbance must be installed ahead of frozen ground.
6. Mulch used for temporary stabilization must be applied at a minimum of 2 inches with an 80-90% cover.

How to comply:

As required by the authorization, temporary stabilization for areas of earth disturbance shall be completed utilizing one or more of the methods below:

Hay or Straw Mulch

Mulching Rates

April 16 - Oct. 14 – Hay or Straw*: 1 inch deep (1-2 bales/1000 s.f.)

Oct. 15 - April 15 – Hay or Straw*: 2 inch deep (2-4 bales/1000 s.f.)

*seed may also be incorporated



Excellent application of hay mulch. Good mulch cover and perimeter control around soil stockpile.

Wood Chip Mulch or Stump Grindings

Cover entire area with 2-7 inches or more of wood chip mulch or stump grindings.



Good application of wood chip mulch and stump grindings.

3. For areas of disturbance within 100 ft of a waterbody, the following must be installed across the slope, down gradient of the earth disturbance:
- a combination of one practice from group A placed in front of a practice from group B, or
 - two group B practices, or
 - a single row of Reinforced Silt Fence

Group A	Group B
Filter Socks	Silt Fence
Straw Wattles	Erosion Control Berms



Use of a combination of silt fence and filter sock in place of reinforced silt fence for winter construction perimeter control requirements in proximity to a water resource area.

2. If seeding is not completed by September 15, additional non-vegetative protection must be used to stabilize the site for the winter period. Areas of disturbance not seeded and mulched by September 15 are required to temporarily stabilize by one of the following methods:

- Implement Rolled Erosion Control Products (i.e. matting) over the areas of earth disturbance.
- Apply a 2" mulch layer to areas of earth disturbance, equivalent to double the standard rate. Mulch should be tracked in open areas vulnerable to wind.
- Seeding with winter rye is recommended to allow for early germination during wet spring conditions.

Requirements for Winter Construction

If construction activities involving earth disturbance continue into the winter construction period, the following requirements apply:

1. Enlarged access points, stabilized to provide for snow stockpiling.
2. Snow shall be managed with adequate storage and control of meltwater, requiring cleared snow to be stored down slope of all areas of disturbance and out of stormwater treatment structures.

Hydroseed

As per manufacturer's instructions.

- Must include mulch component
- Not acceptable stabilization for winter construction period



Excellent application of hydroseed with a mulch component. Entire soil surface has been covered and is temporarily stabilized.



Poor hydroseed application. Not applied at the appropriate rate, soil not prepared, and very little mulch component in mix.

Requirements for Dust Control:

Construction roads, access points, and other disturbed areas subject to surface dust movement and dust blowing during dry periods where off-site damage may occur if dust is not controlled shall be sprayed with water to prevent dust mobilization. **Chemical applications, including the use of chloride, shall not be applied without written approval from the VT DEC.**

Requirements for Final Stabilization:

All areas of disturbance must have permanent stabilization within 48 hours of reaching final grade.

- Bring the site or sections of the site to final grade as soon as possible after construction is completed. This will reduce the need for additional sediment and erosion control measures and will reduce the total disturbed area.
- Prepare bare soil for seeding by grading the top 4 to 6 inches of soil and removing any large rocks or debris, and apply seed per suppliers specifications.

1. For areas to be stabilized for the winter through the establishment of vegetation, seeding and mulching shall be completed no later than September 15 to ensure adequate growth and cover before the start of the winter period.



Stabilization and seeding of slopes before winter will reduce or eliminate erosion in the spring.

12. Winter Construction Requirements October 15 - April 15

Purpose:

'Winter construction' as discussed here, describes the period from October 15 through April 15, when erosion prevention and sediment control is significantly more difficult. There are specific requirements for sites that conduct earth disturbance during the defined Winter Construction Period and for sites where disturbed areas have not reached final stabilization by October 15.

Rains in late fall, thaws throughout the winter, and spring melt and rains can produce significant flows over frozen and saturated ground, greatly increasing the potential for erosion. A construction site can be managed to anticipate these conditions to prevent erosion and thus minimize the risk to water quality during this time period.

Requirements for Winter Shutdown:

For projects or areas of a site that will have completed earth disturbance activities prior to the winter construction period (October 15 through April 15), the following requirements must be adhered to:

5. Stabilized Construction Access

Purpose:

A stabilized construction access helps remove mud and sediment from vehicles and equipment to prevent tracking onto streets.

Requirements:

If there will be any vehicle or equipment traffic off of the construction site, you must install a stabilized construction access at the start of construction.

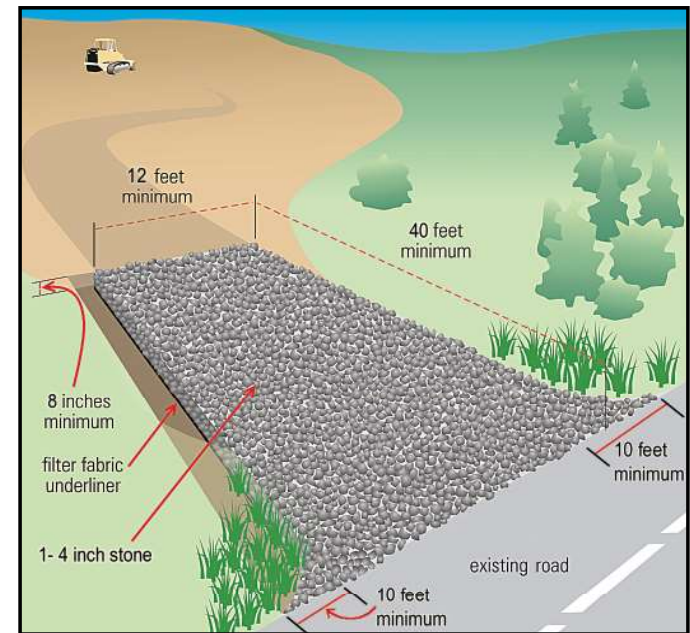

Construction access detail. Access pad must keep mud from tracking onto both paved and gravel roads.

Stabilized Construction Access

How to install:

Rock Size: Use a mix of 1 to 4 inch stone

Depth: 8 inches minimum

Width: 12 feet minimum, flared at road for vehicle turning

Length: 40 feet minimum (or length of driveway for residential projects, if shorter)

Geotextile: Place filter cloth under entire stone bed

Maintenance:

Redress with clean stone or scarify to open voids as required to keep sediment from tracking onto the street.



Good stabilized construction access. Adequate width to accommodate construction traffic and prevent mud tracking offsite. Ensure that the pad is 8 inches deep and 40 feet long.

IMPORTANT NOTE:

Roller Erosion Control Product (RECP) materials have the potential to ensnare animals such as snakes and birds, which can lead to injury or fatality. This has been observed to be most problematic in products with a plastic mesh, whether biodegradable or not.



Accordingly, only woven and interlinked products are approved for use in RECP applications.

(See Tables 4.3 and 4.4 of the Vermont Standards & Specifications for Erosion Prevention and Sediment Control)

Rolled Erosion Control Product:

A preformed protective blanket of straw or other plant residue, formed into a mat, with a supporting mesh framework on one or both sides. This mesh cannot be made of a material with welded joints.

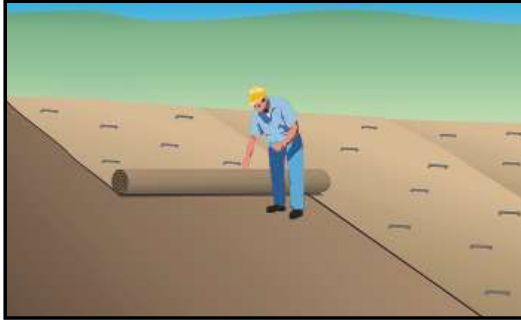

Install blankets and mats vertically on long slopes. Unroll from top of hill and staple as you unroll it. Do not stretch blankets.

Erosion Control Matting:

Install per manufacturer's instructions.



Excellent stabilization of large slopes to limit the area of disturbance. Make sure to install erosion control matting within 48 hours of grading to ensure good contact between soil and mat.



Poor construction access. Rock pad is poorly constructed; rock is too small. Filter fabric is required under the 1 - 4 inch rock. Mud should not be tracked onto street.

- Where sediment has been tracked-out from your site onto paved roads, sidewalks, or other paved areas outside of your site, remove the deposited sediment by the end of the same business day in which the track-out occurs or by the end of the next business day if track-out occurs on a non-business day.
- Remove the track-out by sweeping, shoveling, or vacuuming these surfaces, or by using other similarly effective means of sediment removal.
- You are prohibited from hosing or sweeping tracked-out sediment into any stormwater conveyance, storm drain inlet, or water of the state.

6. Divert Upland Runoff

Purpose:

Diversion berms intercept stormwater runoff contributing from above the construction site and direct it around the disturbed area. This prevents offsite runoff from entering the construction site, thus reducing the potential for erosion and reducing the drainage area contributing to the site.

Requirements:

If stormwater runoff contributes to the construction site from upslope areas and the site meets the following two conditions, you are required to first install a diversion berm and stabilized swale before disturbing any additional soil.

1. One or more acres of soil will be disturbed at any one time.
2. Average slope of the disturbed area is 20% or steeper.*

* See page 63 for slope calculations.

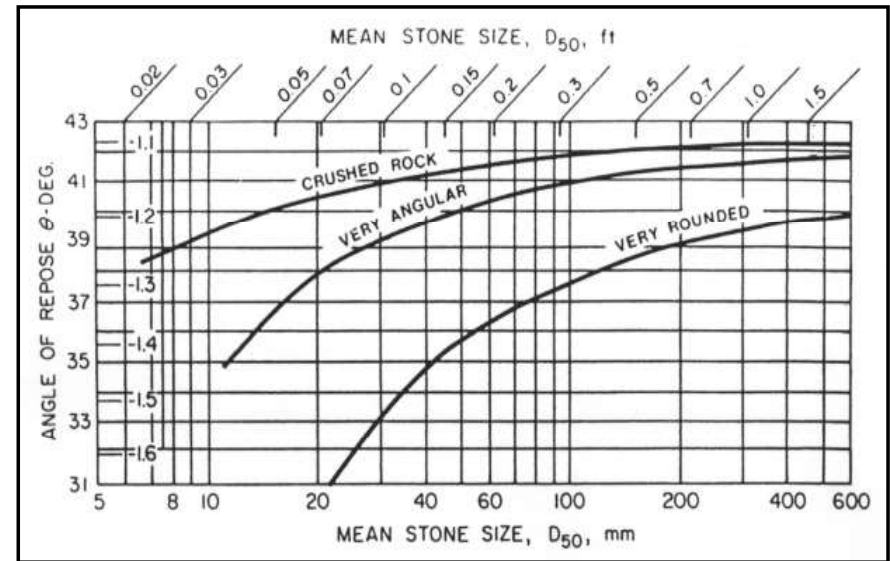

Angle of repose of riprap stones (FHWA)

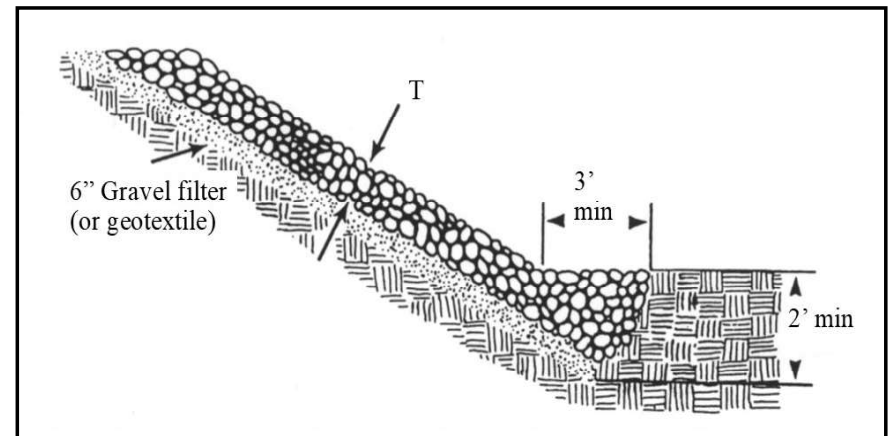

Typical riprap slope protection detail

11. Slope Stabilization

Purpose:

Surface covering designed to protect and stabilize an area prone to erosion where seeding and mulching may be inadequate, generally slopes 3:1 or greater. The erosion potential may be due solely to slope angle; however, a more gradual slope and poor soil structure can also require additional stabilization.

Requirements for Temporary Stabilization:

Use of one of the listed slope protection practices below on slopes 3:1 and greater or as needed on flatter slopes based on soil type.

Riprap: A layer of stone designed to protect and stabilize areas subject to erosion.



Stone rip-rap installed on an unstable slope with a stormwater outlet pipe along the slope.



Berms and ditches divert upslope contributing runoff around construction sites and reduce erosion and sedimentation problems. Stabilize berms and ditches after construction.

Diversion Berm installation:

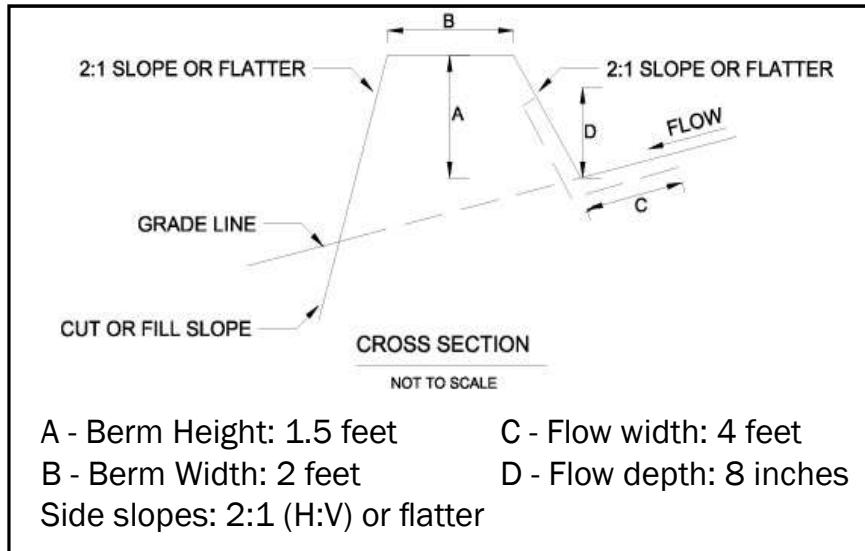

1. Construct berm to the minimum specification above.
2. Compact the berm with a shovel or earth-moving equipment.
3. Seed and mulch berm or cover with erosion control matting immediately after installation.
4. Stabilize the flow channel with seed and mulch or erosion control matting. Line the channel with 4 inch stone if the channel slope is greater than 20%.
5. Ensure the berm drains to an outlet stabilized with riprap. Ensure that there is no erosion at the outlet.



Before installing rock outlet protection



After installing rock outlet protection

Slow Down Channelized Runoff

Rock Outlet Protection:

- Waterways or outlets with concentrated stormwater runoff shall be stabilized with riprap, proprietary stabilization product or permanent material. This additional stabilization is applicable in areas where the channel slope and velocity or soil type require additional stabilization.
- All outlets from concentrated stormwater flows will require a stabilized bed.
- Stone shall be sized so it is not mobilized during high flows.

The images on page 44 show the before and after of an eroding channel from a culvert outlet, stabilized with stone, to a small pool for energy dissipation at the bottom of the slope.

6. The diversion berm shall remain in place until the disturbed areas are completely stabilized.



Good construction, seeding, and stabilization of diversion berm. Note that diversion ditch is lined with grass on flatter part of slope, and with rock on steeper part.

7. Install Perimeter Controls

Purpose:

Silt Fence and Erosion Control Berms intercept runoff and allow suspended sediment to settle or filter out. Filter Socks and Straw Wattles also filter construction runoff and are acceptable for use in specific situations.

Silt Fence, Erosion Control Berms, Filter Socks and Straw Wattles are all acceptable perimeter controls based on site specific conditions. Permittee(s) must ensure the right practice is selected for erosion prevention and sediment control.

Requirements:

Perimeter controls must be installed:

- On the downhill side of the construction activities
- Between any ditch, swale, storm drain, or surface water and the disturbed soil
- Perimeter controls not labeled as biodegradable shall be removed once the drainage area has reached final stabilization

* Hay bales must not be used exclusively as sediment barriers due to their tendency to degrade and fall apart and may only be used in support of other required practices.



Good installation of rock check dams. The check dams should extend up the sides of the banks. Middle section should be lower than the sides. Clean out sediment as it accumulates.



Hay bales must not be used as check dams due to their high failure rates.

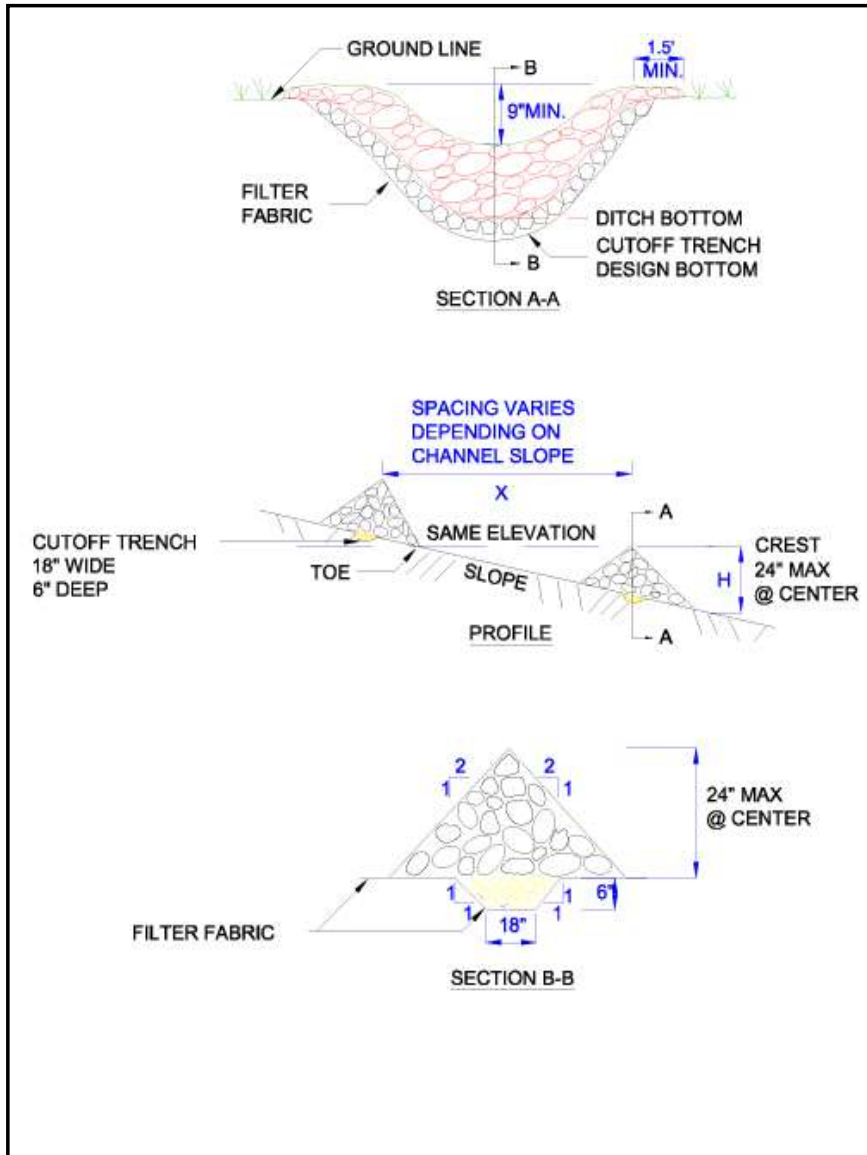

How to Comply:

Select and install a perimeter control from the following options: Silt Fence, Erosion Control Berms, Filter Socks, or Straw Wattles.

Where to place:

- Place perimeter controls on the downhill side of disturbed soil. If space is available, place perimeter control 10 ft from the bottom of the slope, otherwise place along the contour at the bottom of the slope.
- Ensure the perimeter control catches all runoff from disturbed soil.
- Maximum drainage area is ¼ acre for 100 feet of silt fence and erosion control berm.
- Install perimeter controls across the slope (not up and down slope)
- Install multiple rows of perimeter control on long slopes to intercept flow.
- Do not install perimeter controls across ditches, channels, or streams.
- Maximum slope length (in feet) above a filter sock or straw wattle:

Slope (%)	Sock Diameter (in)			
	12"	18"	24"	32"
<5	225	250	275	325
5-10	125	150	200	275
10-20	65	70	130	150
20-25	50	55	100	120
25-33	40	45	60	75
>33	25	30	35	50

Slope	Straw Wattle (12")
<6:1	50
6:1-4:1	25
4:1-2:1	20
2:1-1:1	10
>1:1	5

Perimeter Control Construction Specifications

Silt Fence

A temporary barrier of geotextile fabric installed on the contours across a project site to intercept sediment laden runoff from small drainage areas of disturbed soil.

Silt Fence Installation:

- Dig a trench 6 inches deep across the slope
- Unroll silt fence along the trench
- Ensure stakes are on the downhill side of the fence
- Join fencing by rolling the end stakes together
- Drive stakes in against downhill side of trench
- Drive stakes until 16 inches of fabric is in trench
- Push fabric into trench; spread along bottom
- Fill trench with soil and pack down
- Gravel can be used to create ground contact with filter fabric when bedrock, ledge, or nearby tree roots do not allow for trenching. (A secondary perimeter control can be effective in these locations as well.)

- **Spacing:** Space the dams so that the bottom (toe) of the upstream dam is at the elevation of the top (crest) of the downstream dam. This spacing is equal to the height of the check dam divided by the channel slope.

$$\text{Spacing (in feet)} = \frac{\text{Height of check dam (in feet)}}{\text{Slope in channel (ft/ft)}}$$

Check Dam Maintenance:

- Correct all observed damage immediately after every runoff event.
- Remove all sediment accumulated behind the check dams and dispose of in an upland location.
- If significant erosion is observed between check dams, the channel shall be stone lined.

10. Slow Down Channelized Runoff

Purpose:

Stone check dams reduce erosion in drainage channels by slowing down the stormwater flow.

Requirements:

If there is a concentrated flow (e.g. in a ditch or channel) of stormwater on your site, then you are required to install stone check dams. Hay bales and silt fence must not be used as check dams.

Check Dam installation:

- **Height:** No greater than 2 feet. Center of dam should be 9 inches lower than the side elevation
- **Side slopes:** 2:1 or flatter (see p.63 for slope calculation)
- **Stone size:** Use a mixture of 2 to 9 inch stone; the larger stone should act as armoring, while the smaller stone helps to filter the channelized runoff. The small stone should be placed primarily in the interior of the check dam and the large stone should be placed in an armoring layer on the outside.
- **Width:** Dams should span the width of the channel and extend up the sides of the banks

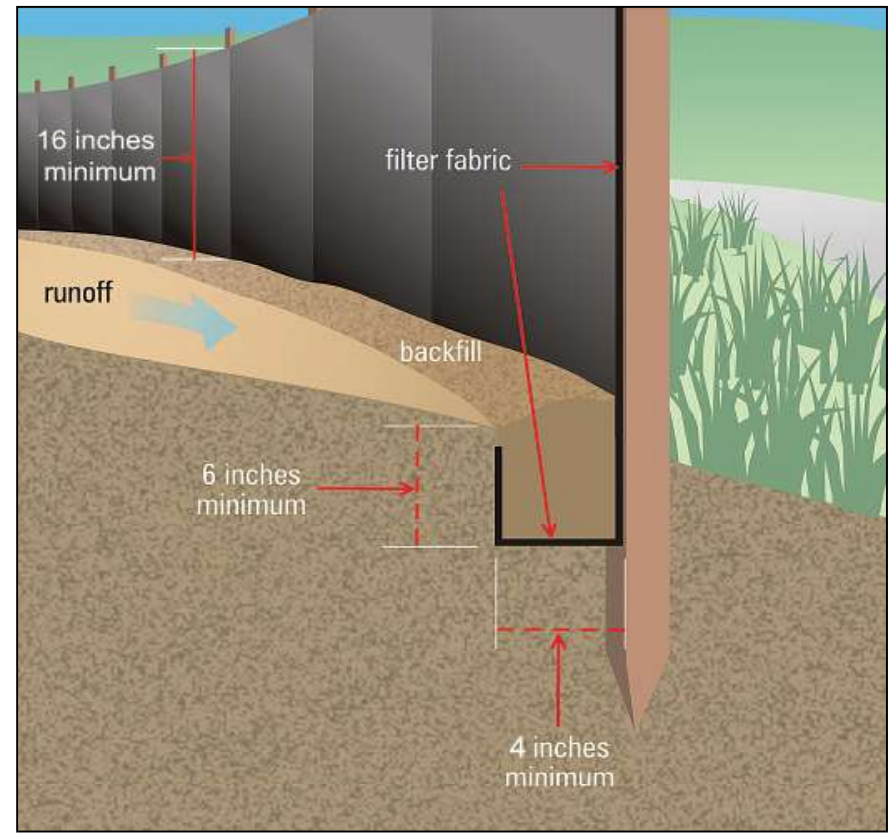

Silt Fence Maintenance:

- Remove accumulated sediment before it is halfway up the fence.
- Ensure that silt fence is trenched in ground and there are no gaps.
- Replace any silt fence that is torn, ripped, or otherwise damaged that is no longer effective.

Good use of J-hook in silt fence to trap sediment in water running along the fence. Sediment must be removed before it reaches halfway to top of fence.

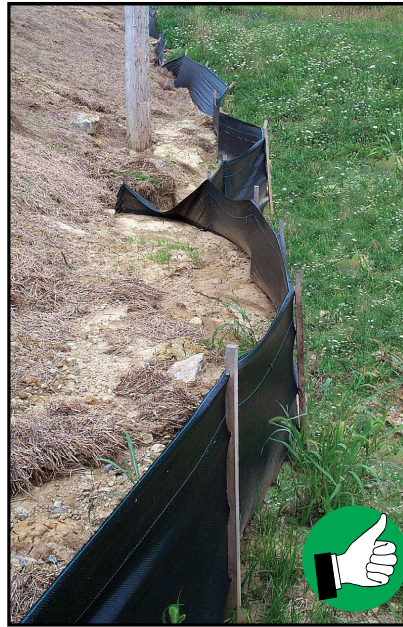

Poor installation of silt fencing. Silt fence must be trenched in along bottom. Hay bales are not approved as sediment barriers.

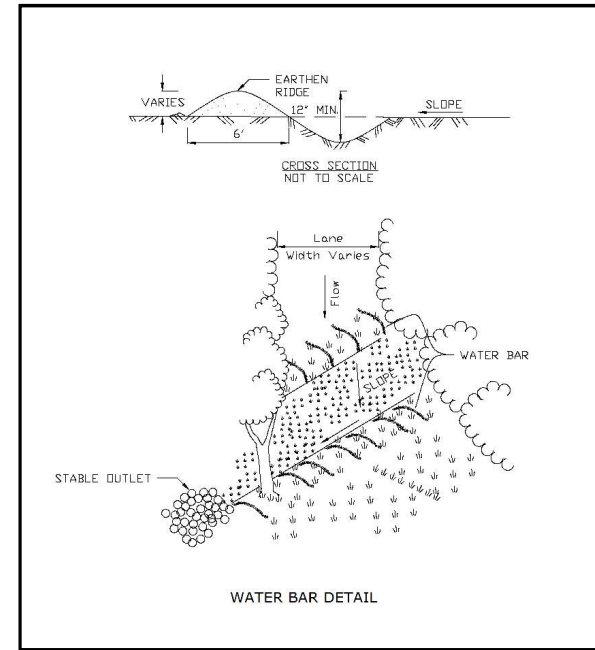

Good installation of a water bar along an access road.

9. Water Bars

Purpose:

Some sites may benefit from the use of water bars on the construction site. When installed these may capture and redirect runoff to a stable low gradient location. Water bars limit the erosive velocity of water by diverting surface runoff at pre-designed intervals.

Requirements:

These can be constructed per the following detail, with side slopes no steeper than 4:1 where vehicles cross with a minimum design height of 12 inches, measured from channel bottom to ridge top.

Water Bar installation:

Water bars should have stable outlets, either natural or constructed. The spacing should follow Table 1.

Table 1. Water Bar Spacing

Slope (%)	Distance between structures (ft)
< 5	125
5 - 10	100
10 - 20	75
20 - 35	50
> 35	25



Excellent installation of reinforced silt fence and j-hooks in front of a stone-lined drainage channel.

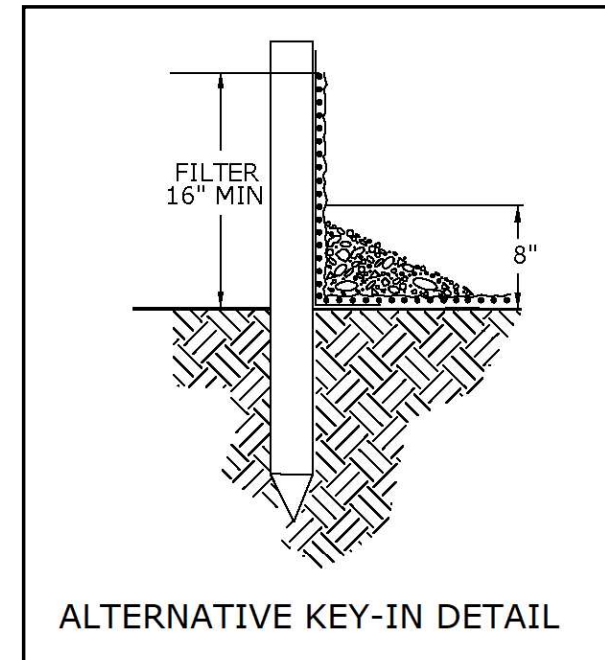

Erosion Control Berms

Erosion control berms are comprised of a dense mixture of intertwining wood fragments and grit that form a stable, long lasting mulch. Common sources include stump grindings, and aged wood waste.

Erosion Control Berm Installation:

- Stump grindings from land clearing are an excellent source of material for erosion control berms, and may be readily produced when the area to be developed is forested.
- Erosion control berms are effective on frozen ground, rock outcrops, and forested areas with heavy root cover. It may be necessary to pack down or remove vegetation to prevent the creation of voids or bridges which will allow berm washout and pass sediment laden water offsite.
- The erosion control berm should be a minimum of 1 foot tall and 2 feet wide. On longer or steeper slopes a larger berm may be necessary.

Erosion Control Berm Maintenance:

- Erosion control berms must be redressed and reshaped as necessary to ensure that sediment doesn't accumulate more than halfway up the berm face.



Use of stone inlet protection with the incorporation of a straw wattle in place of cinder blocks for the stone and block specification.

Filter Fabric and Stone Inlet Protection:

Vertical filter fabric installed around drop inlet with stone around fabric for stormwater filtering and creating ground contact with filter fabric. Alternatively, fabric may be buried below ground.

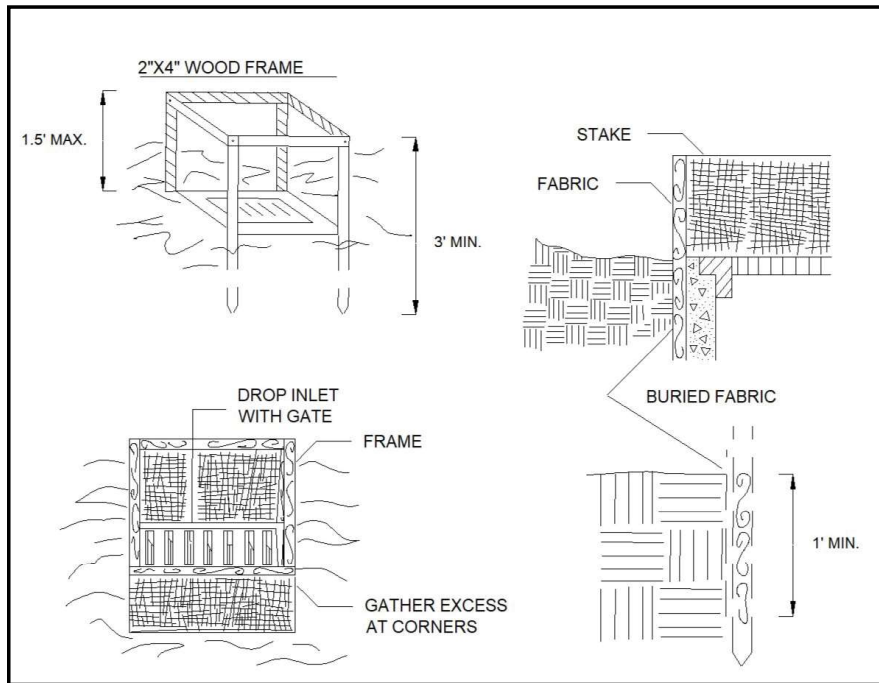

The erosion control berm above is allowing for both ponding and filtering of stormwater.

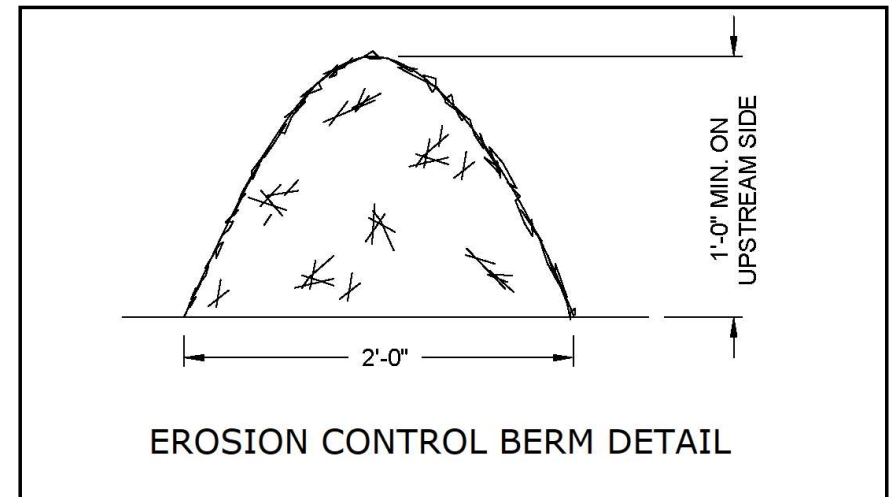

Filter Socks

A manufactured tube made of either a synthetic material or an organic fiber which is filled with erosion control mix or other finely shredded organic material such as coconut fiber. They are an excellent practice for slowing runoff on long open slopes and for use around stockpiles.

Filter Sock Installation:

- Filter socks are best used for small areas of disturbance, at the base of stockpiles, across slope contours and across paved areas.
- Full contact with the ground is critical for filter socks to be effective and to prevent bypass. A trench 2"-3" deep shall be dug along the path of the filter sock, with the exception of installations across paved areas.
- Most applications will require staking at 10 ft intervals, which should help both keep the filter sock in place and push it downward for maximum contact with the ground.

Filter Sock Maintenance:

- Accumulated sediment should be removed and placed in an upland location when material reaches half of the filter sock height.
- Filter socks can be reshaped if they become flattened or caked in sediment.

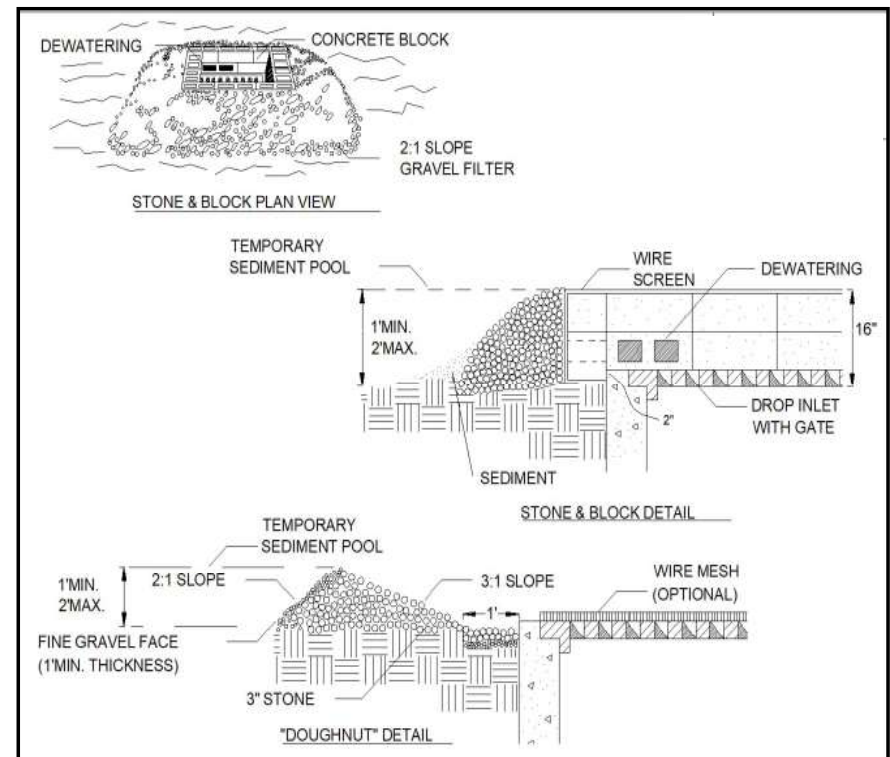

8. Storm Inlet Protection

Purpose:

Existing or new storm inlets on construction sites constitute a site perimeter and must be protected from sediment laden runoff. The practices below allow stormwater to settle and filter through the practice and not bypass the inlet entirely.

Requirements:

Stormwater inlets shall be 4 inches above grade or an acceptable inlet control/protection should be installed.

Inlet Protection Installation:

Proprietary Inlet Protection:

Shall provide for storage and removal of sediment and be sized appropriately for the drainage area, while allowing stormwater to filter through. These may be used if installed and maintained in accordance with the manufacturer's specifications.

Stone and Block Inlet Protection:

Concrete blocks placed around an inlet with a circle of filtering stone sloped against the blocks.

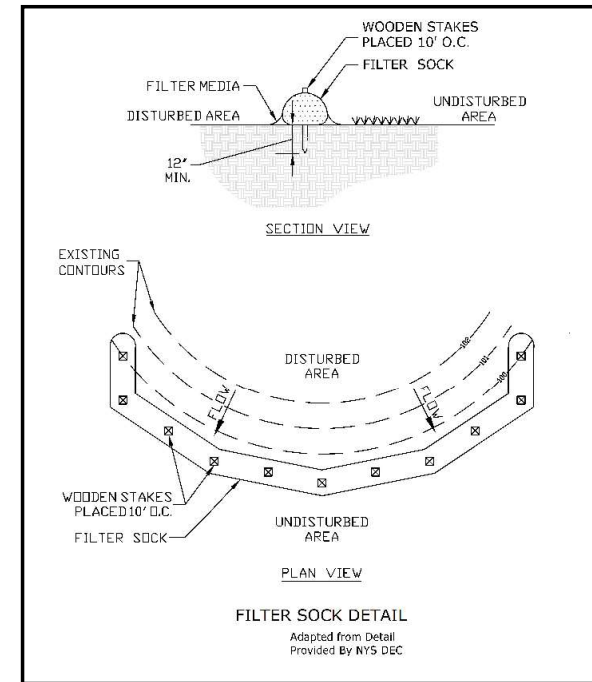

Good use of filter socks along a slope to slow runoff velocity.

Straw Wattles

Straw wattles are similar to filter socks, but with less density due to straw filling material. These can be used in successive rows to slow sheet flow and collect sediment on long slopes or around the base of soil stock piles, but are not appropriate for application on impervious surfaces such as asphalt, concrete, or ledge.

Straw Wattle Installation:

Straw Wattles are best used for small areas of disturbance, at the base of stockpiles, and across slope contours.

- Full contact with the ground is critical for straw wattles to be effective and to prevent short circuiting. A trench 2"-3" deep shall be dug along the path of the wattle.
- Straw wattles shall be secured with 18-24" stakes every 3-4' and with a stake at each end. Stakes shall be driven through the middle of the wattle and perpendicular to slope, leaving at least 2-3" of stake extending above wattle. In limited cases, wattles may be secured without stakes by use of sandbags if staking is not feasible.
- Adjacent wattles shall tightly abut or overlap.

Straw Wattle Maintenance:

- Accumulated sediment should be removed and placed in an upland location.

- Straw wattles can be reshaped if they become flattened or caked in sediment.

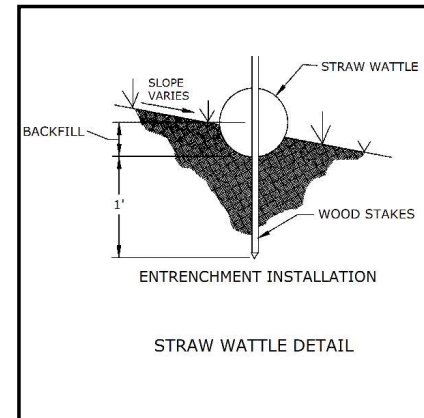
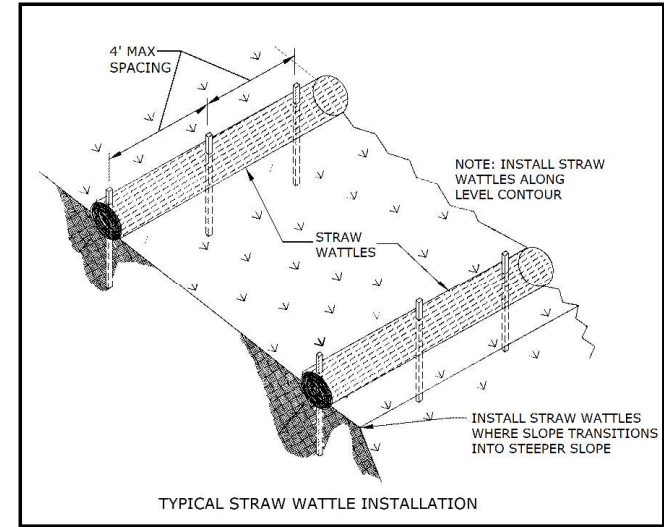

Straw wattle properly staked in and providing settling of runoff from this shallow slope. Note a clean wattle was placed in front of an older less effective wattle.